

HKTS 5

Home theater speaker system

Owner's Manual



harman/kardon[®]
by HARMAN

HKTS 5

Introduction, Description and Features, and Included Items

Introduction

Thank you for purchasing the harman kardon® HKTS 5 speaker system, with which you're about to begin many years of listening enjoyment. The HKTS 5 has been custom designed to provide all the excitement and power of the cinema experience in your own living room.

While sophisticated electronics and state-of-the-art speaker components are hard at work within the HKTS 5, hookup and operation are simple. Color-keyed cables and connections and simple controls make the HKTS 5 easy to use.

To obtain maximum enjoyment from your new home theater speaker system, we urge you to take a few minutes to read through this manual. It will help ensure that the connections you make to your receiver (or preamp/processor), amplifier and other devices are correct. In addition, a few minutes spent learning the functions of the various controls will enable you to take advantage of all the power and refinement the HKTS 5 is able to deliver.

If you have any questions about this product, its installation or its operation, please contact your dealer, the best local source of information.

Description and Features

The HKTS 5 is a complete six-piece home theater speaker system that includes:

- An 8-inch (200mm), 60-watt powered subwoofer
- Four identical, two-way, satellite speakers for the front left, front right, surround left and surround right speaker positions
- A dedicated, voice-matched, dual-driver center speaker
- Shelf stands and wall-mount brackets for the satellite speakers and a wall-mount bracket for the center speaker
- All of the cables you need to connect all of the speakers to your receiver or preamp/processor and amplifier

The speaker cables all use a color-coding system to conform to the Consumer Electronics Association (CEA®) standard. This color-coding system minimizes confusion when connecting the speakers, especially when the HKTS 5 system is used with a harman kardon receiver.

Shelf stands and wall-mount brackets are included for the satellite and center speakers, and shelf stands are included for the satellite speakers. Optional HTFS 2 floor stands are available separately from your harman kardon dealer.

harman kardon engineers invented the high-fidelity receiver fifty years ago. With state-of-the-art features and time-honored circuit designs, the HKTS 5 is a perfect complement to a harman kardon receiver or any home theater system.

Included Items

One HKTS 160SUB subwoofer

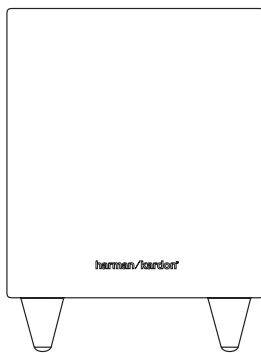

One center-channel speaker



Four satellite speakers: a front left speaker, a front right speaker and two rear surround-sound speakers (shown with included shelf stands attached).

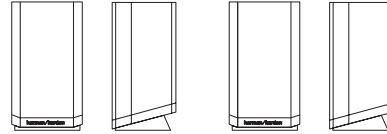

Four wall-mount brackets for satellite speakers



One wall-mount bracket for center-channel speaker

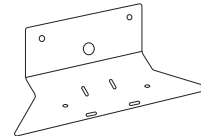

One LFE (low-frequency effects) for connection to the subwoofer (LFE cable has purple connectors)



Three six-meter (19.7-foot) speaker cables for connection to front satellites (red and white) and to center speaker (green)

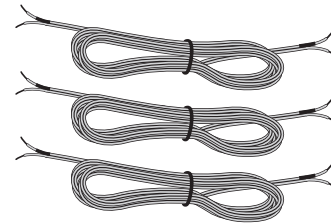

Two 12-meter (39.4-foot) speaker cables for connection from receiver to rear surround-sound satellites (gray and blue)

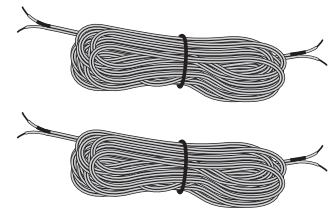

HKTS 160SUB Rear-Panel Connections

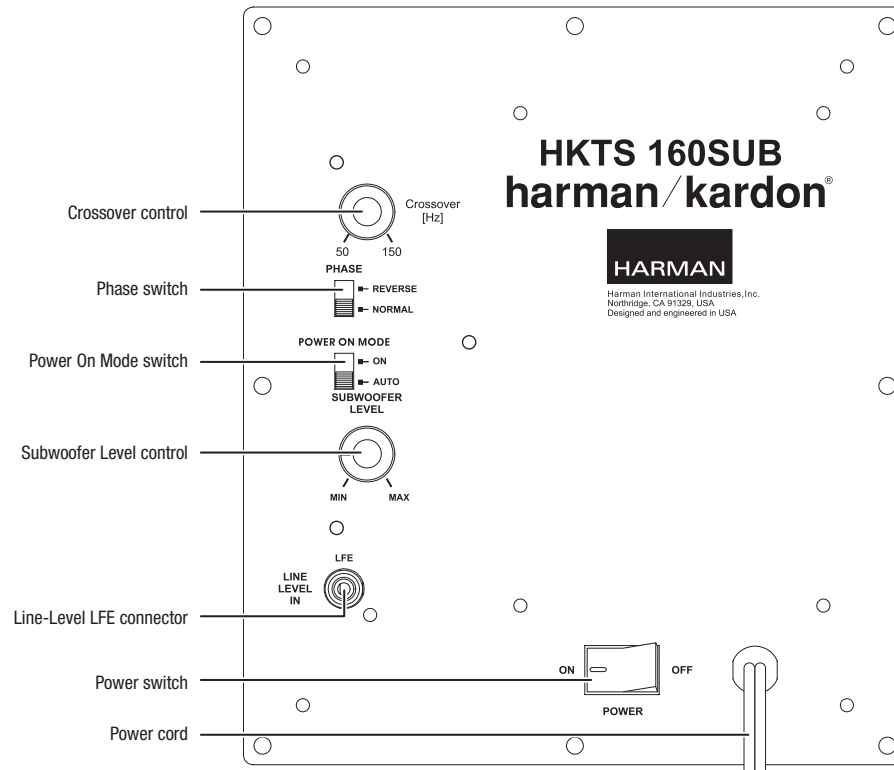

Crossover control: This knob adjusts the subwoofer's cutoff between 50Hz and 150Hz. The higher you set the Crossover control, the higher in frequency the subwoofer will operate and the more its bass will "overlap" that of the system's other speakers. This adjustment helps achieve a smooth transition of bass frequencies between the subwoofer and the system's other speakers for a variety of different rooms and subwoofer locations.

NOTE: If you have connected the subwoofer to a receiver/processor with a low-pass filtered LFE output, set the subwoofer's Crossover control to the 150Hz position (fully clockwise).

Phase switch: The Phase switch determines whether the HKTS 160SUB's piston-like action moves in and out in phase with the satellite speakers. If the subwoofer were to play out of phase with the satellite speakers, the sound waves produced by the subwoofer could be canceled out, reducing bass performance and sonic impact. This phenomenon depends in part on the relative placement of all the speakers in the room. In most cases the Phase switch should be left in the "NORMAL" position. However, it does no harm to experiment, and you can leave the Phase switch in the position that maximizes bass response and impact.

Power On Mode switch: If this switch is set in the "AUTO" position and the Power switch is set to "ON", the HKTS 160SUB will automatically turn itself on when it receives an audio signal and will enter the standby mode once no audio signal has been received for about 15 minutes. When this switch is set in the "ON" position, the HKTS 160SUB will remain on whether or not it is receiving an audio signal. An LED on the HKTS 160SUB's top panel indicates whether the subwoofer is in the on or standby state:

- When the LED glows white, the HKTS 160SUB is turned on.
- When the LED is not illuminated, the HKTS 160SUB is in standby mode.

When the Power switch is set to "OFF", the LED will not be illuminated, no matter what setting the Power On Mode switch is in.

Subwoofer Level control: Use this control to adjust the HKTS 160SUB's volume. Turn clockwise to increase the volume; turn counterclockwise to decrease the volume.

Line-Level In/LFE connector : Connect the subwoofer output of your receiver or preamp/processor to this jack. The signal from this connector passes through the subwoofer's internal low-pass crossover.

Power switch: Set this switch in the "ON" position to turn the HKTS 160SUB on. The subwoofer will then either be on or in standby mode, depending on the setting of the Power On Mode switch.

Power cord (non-detachable): After you have made and verified all subwoofer and speaker connections described in this manual, plug this cord into an active, *unswitched* electrical outlet for proper operation of the HKTS 160SUB. **DO NOT** plug this cord into the accessory outlets found in some audio components.

Speaker Placement

Color-Coding System

The HKTS 5 uses the CEA color-coding system to make setting up your home theater speaker system as easy as possible. Your system includes a set of colored stickers that may be placed near the speaker terminals of each of the four satellite speakers according to the key below. It doesn't matter which satellite speaker is used for any of the front or rear positions. (The center speaker and powered subwoofer are already color-coded for you.)

Speaker Position	Wire Color Band
Front Left	White
Front Right	Red
Center	Green
Surround Left	Blue
Surround Right	Gray
Subwoofer	Purple

Front Speakers

Place the front speakers the same distance from each other as they are from the listening position (the place where you'll be when you listen to the HKTS 5). They should be placed at about the same height from the floor as the listener's ears will be. They also can be angled toward the listener.

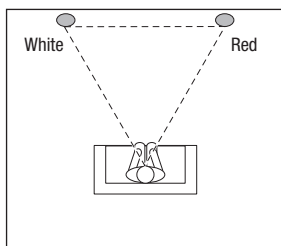

Center Speaker

The center speaker should be placed slightly behind (farther away from the listener) the front left and right speakers. Its center should be no more than 55 cm (2 feet) above or below the tweeters of the front left and right speakers. It is often convenient to set the center speaker on top of the television set, as shown in the drawing.

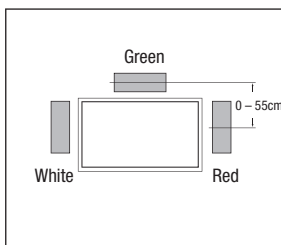

Subwoofer

The low-frequency sound reproduced by the subwoofer is mostly omnidirectional, and this speaker may be placed in a convenient location in the room. However, the best reproduction of bass will be heard when the subwoofer is placed in a corner along the same wall as the front speakers. Experiment with subwoofer placement by temporarily placing the subwoofer in the listening position and moving around the room until the bass reproduction is best. Place the subwoofer in that location.

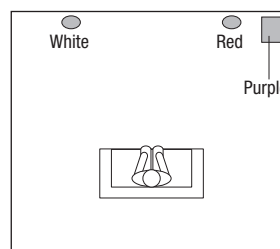

Surround Speakers

Place the two surround speakers slightly behind the listening position. Ideally, they should face each other and be at a level higher than the listeners' ears. If that is not possible, they may be placed on a wall behind the listening position, facing forward. The surround speakers should not call attention to themselves. Experiment with their placement until you hear a diffuse, ambient sound accompanying the main program material heard in the front speakers.

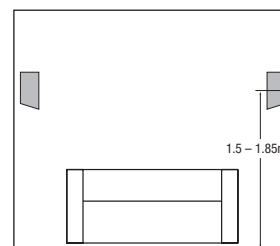
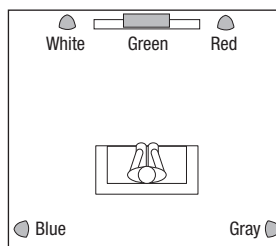

Mounting Options

You can place the satellite and center speakers on shelves using their built-in stands, or you can wall-mount them using the supplied hardware.

Wall-Mounting the Satellites

1. Remove the black shelf stand from the bottom of the speaker by unscrewing the bolt. Store the shelf stand and bolt in a safe place in case you need them in the future.

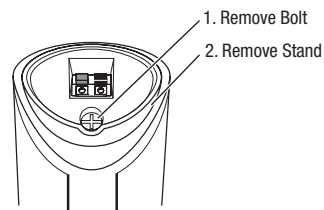

2. Determine the locations for the speakers. If possible, position the speakers so that the mounting screws (not included; use size #8) can be installed directly into a wall stud. If that is not possible, use optional wall anchors that are rated to support at least 25 lb (11.3kg) and are appropriate for the construction and materials of your wall. **The customer is responsible for the proper selection and use of mounting hardware, available through hardware stores, to wall-mount the speakers properly and safely.**

- Bring the speaker cable through the wall-bracket attachment plate, and mount the attachment plate on the wall in the desired location.

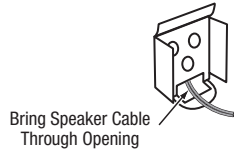

- Thread the speaker cable through the arc-shaped opening on the top of the mounting bracket, not the screw hole.

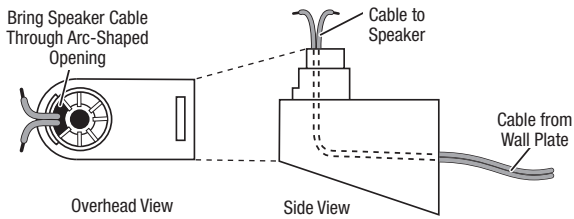

- Attach the mounting bracket to the wall plate by inserting the tab at the top of the attachment plate into the slot on top of the bracket and snapping the bracket onto the attachment plate.

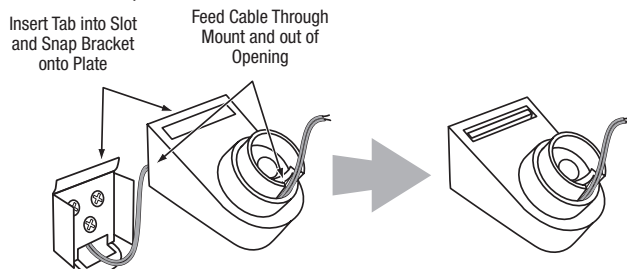

- Fit the terminal cover onto the bracket as shown in the illustration below, then connect the speaker leads to the terminals on the underside of the speaker. Remember to observe the correct polarity.

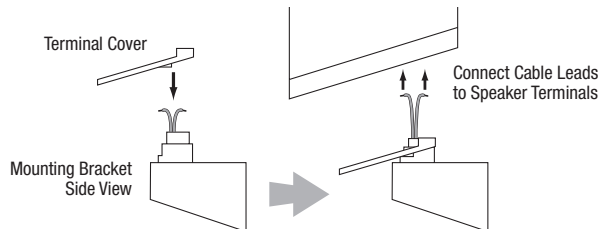

- Fit the terminal cover into the opening on the underside of the speaker so that it is flush against the speaker and covers the terminals. Insert the supplied long bracket bolt up through the bottom of the bracket and terminal cover, and screw it into the threaded insert on the underside of the speaker. The bolt should be snug but not so tight as to prevent the speaker from pivoting on the bracket.

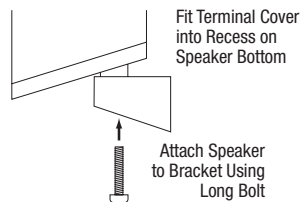

You can pivot the wall-mounted speaker from side to side; however, attempting to tilt it up or down will damage the bracket and possibly the wall, which would not be covered by your warranty.

Wall-Mounting the Center Speaker

- Determine the location for the speaker. If possible, position the speaker so that one of the mounting screws (not included; use size #10) can be installed directly into a wall stud. If that is not possible, use optional wall anchors that are rated to support at least 25 lb (11.3kg) and are appropriate for the construction and materials of your wall. **The customer is responsible for the proper selection and use of mounting hardware, available through hardware stores, to wall-mount the speaker properly and safely.**
- Bring the speaker cable through the wall-bracket attachment plate as shown, and mount the attachment plate on the wall in the desired location.

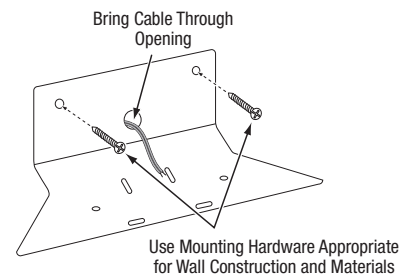

- Remove the rubber pads from the foot rests on the bottom of the center speaker and connect the speaker leads to the terminals on the underside of the speaker. Remember to observe the correct polarity.

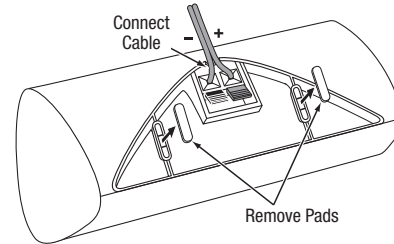

- Use the supplied screws to attach the speaker to the wall-mount bracket. The screws thread into the center foot-rest openings that were exposed when you removed the rubber pads in the previous step.

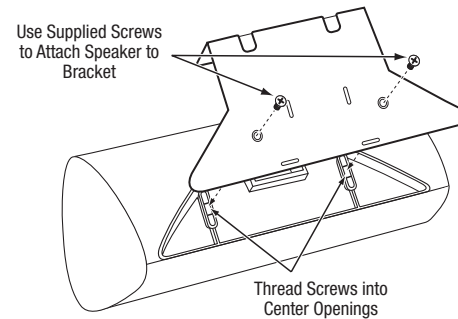

Speaker Connections

IMPORTANT NOTE: Before making speaker connections, be certain that your receiver or audio power amplifier is turned off and preferably unplugged from its AC power source. Do not connect the HKTS 160SUB subwoofer to an AC power source until you have made all speaker-wire connections.

Speakers and other electronics have corresponding (+) and (-) terminals. Most makers of electronics, including harman kardon engineers, use red to denote the (+) terminal and black for the (-) terminal.



Newer harman kardon receivers conform to the CEA standard and therefore use a color other than red or black for the (+) terminal to indicate some speaker positions: e.g., surround left.

Although the HKTS 5 system has red and black collars on the individual speaker terminals to denote the positive and negative connections, your system includes a colored band on

the positive lead at both ends of every speaker cable and a matching colored sticker for each of the four satellite speakers, conforming to the key on page 4. The center speaker has a green (+) terminal, and the subwoofer has a purple SUB input jack. This system is intended to help you ensure that the speaker in each location is connected to the correct terminals on your receiver or amplifier.

The (+) lead of the speaker wire is indicated with a stripe and has the colored band corresponding to the speaker's position. It is important to connect all speakers identically: (+) on the speaker to (+) on the amplifier and (-) on the speaker to (-) on the amplifier.

With the advent of multichannel surround-sound systems, connecting all of the speakers in your system with the correct polarity remains equally important in order to preserve the proper ambience and directionality of the sound.

To connect the supplied speaker wires to the satellite and center speaker terminals located on the bottom of each speaker, press the red or black tab, insert the bare end of the wire into the hole, and release the tab. Gently tug on the wire to make sure that it is fully inserted.

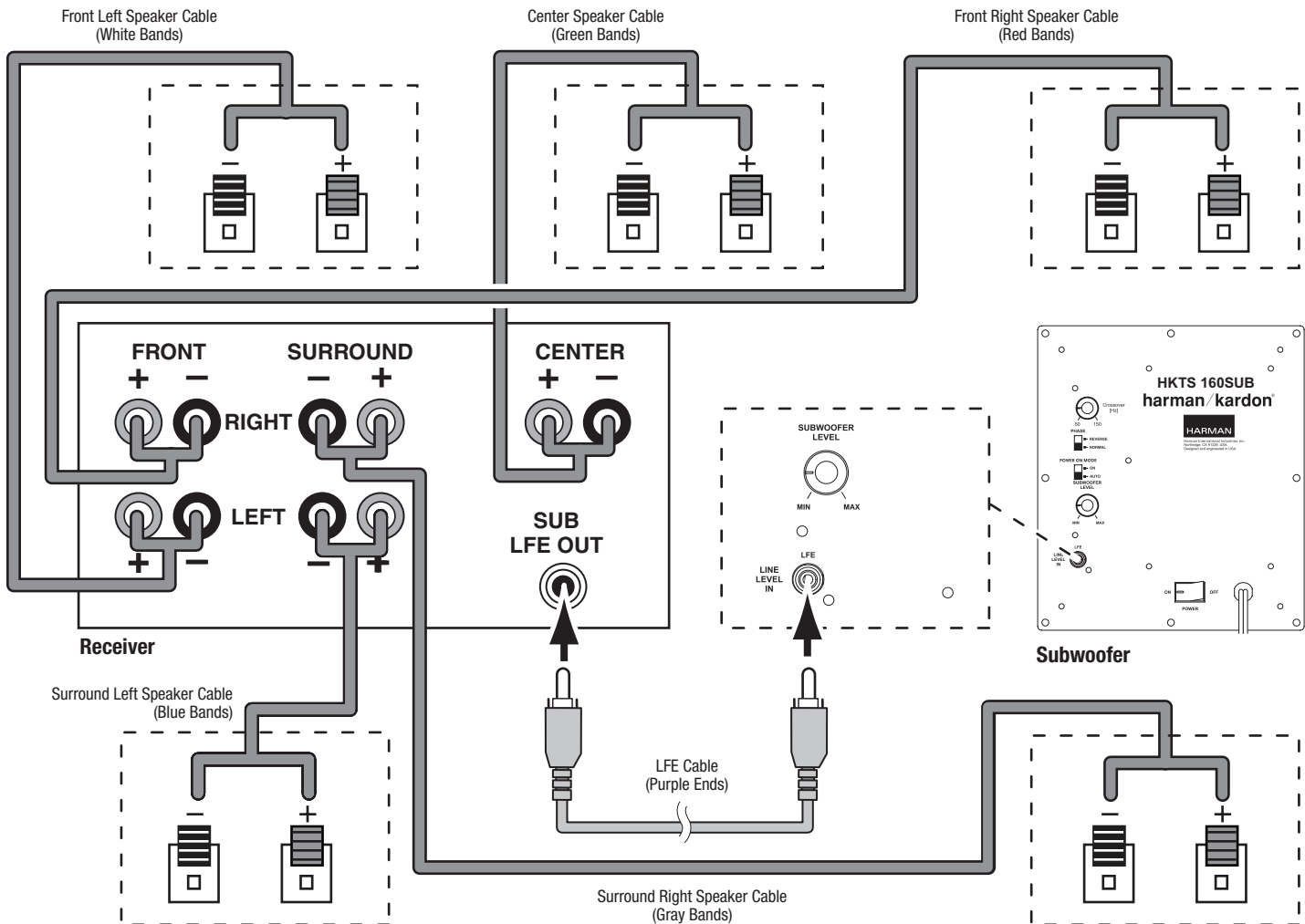

Connecting the Subwoofer

Use the LFE (purple) connector to connect the HKTS 160SUB's Line-Level LFE In connector to the dedicated subwoofer output (or LFE output) of your receiver or preamp/processor. If the receiver or preamp/processor has a low-pass filter on the subwoofer output, set the subwoofer's Crossover Control to maximum (150 Hz).

Connect each satellite speaker and the center speaker to the corresponding speaker terminals on your receiver or amplifier.

In your receiver or preamp/processor's setup menu, configure the receiver or preamp/processor for "Subwoofer ON," and set the front, center and surround speakers to "Small." After you have made and verified all connections, plug the HKTS 160SUB's AC Power cord into an active AC outlet.

Operation

Turning the Subwoofer On and Off

Set the HKTS 160SUB's Power switch to the "ON" position.

- If the Power On Mode switch is set to "AUTO", the HKTS 160SUB will automatically turn itself on when it receives an audio signal, and it will go into standby mode when it has received no audio signal for 15 minutes. The subwoofer's LED will glow white when the subwoofer is on and will not be illuminated when the subwoofer is in standby.
- If the Power On Mode switch is set to "ON", the HKTS 160SUB will remain on at all times. The HKTS 160SUB's LED will glow white.

If you will be away from home for an extended period of time, or if you will not be using the subwoofer for an extended period, switch the Power switch to the "OFF" Position.

Subwoofer Adjustments: Volume

Use the Subwoofer Level control to set the HKTS 160SUB's volume. Turn the knob clockwise to increase the subwoofer's volume; turn the knob counterclockwise to decrease the subwoofer's volume.

Subwoofer Adjustments: Phase

The Phase switch determines whether the HKTS 160SUB's piston-like action moves in and out in phase with the satellite speakers. If the subwoofer were to play out of phase with the satellite speakers, the sound waves produced by the subwoofer could be canceled out, reducing bass performance and sonic impact. This phenomenon depends in part on the relative placement of all the speakers in the room.

Although in most cases the Phase switch should be left in the "NORMAL" position, there is no absolutely correct setting for the Phase switch. When the HKTS 160SUB is properly in phase with the satellite speakers, the sound will be clearer and have maximum impact, making percussive sounds like drums, piano and plucked strings sound more lifelike. The best way to set the Phase switch is to listen to music that you are familiar with and set the switch in the position that gives drums and other percussive sounds maximum impact.

Subwoofer Adjustments: Crossover

The subwoofer's Crossover control adjusts the subwoofer's cutoff between 50Hz and 150Hz. The higher you set the Crossover control, the higher in frequency the subwoofer will operate and the more its bass will "overlap" that of the system's other speakers. This adjustment helps achieve a smooth transition of bass frequencies between the subwoofer and the other speakers for a variety of different rooms and subwoofer locations.

To set the Crossover control, listen for the smoothness of the bass. If the bass seems too strong at certain frequencies, try a lower Crossover control setting. If the bass seems too weak at certain frequencies, try a higher Crossover control setting.

Troubleshooting

This unit is designed for trouble-free operation. Most problems users encounter are due to operating errors. So if you have a problem, first check this list for a possible solution. If the problem persists, consult your authorized harman kardon service center.

Problem	Solution
If no sound comes from <i>any</i> of the speakers:	<ul style="list-style-type: none"> • Check that the receiver/amplifier is on and a sound source is playing. • Make sure that all wires between the receiver/amplifier and the soundbar are connected properly. • Make sure that none of the speaker wires is frayed, cut or punctured. • Review the proper operation of your receiver/amplifier.
If there is no sound coming from <i>one speaker</i> :	<ul style="list-style-type: none"> • Check that the balance control on your receiver/amplifier is not set all the way to one channel. • Check your receiver/amplifier's speaker-setup procedure to make sure that the speaker in question has been enabled and that its volume level has not been turned all the way down. • Make sure that all wires between the receiver/amplifier and the speaker terminals are connected properly. • Make sure that the speaker wires are not frayed, cut or punctured.
If there is no sound coming from the <i>center speaker</i> :	<ul style="list-style-type: none"> • Check your receiver/amplifier's speaker-setup procedure to make sure that the center speaker has been enabled and its volume level has not been turned all the way down. • Make sure that all wires between the receiver/amplifier and the center speaker terminals are connected properly. • Make sure that the speaker wires are not frayed, cut or punctured. • If your receiver is operating in Dolby® Pro Logic® mode, make sure that the center speaker is not set to "Phantom."
If there is no sound coming from the <i>surround speakers</i> :	<ul style="list-style-type: none"> • Check your receiver/amplifier's speaker-setup procedure to make sure that the surround speakers have been enabled and their volume levels have not been turned all the way down. • Make sure that all wires between the receiver/amplifier and the surround speaker terminals are connected properly. • Make sure that the speaker wires are not frayed, cut or punctured. • Review proper operation of your receiver/processor and its surround-sound features. • Make sure that the movie or TV show you're watching has been recorded in a surround-sound mode. If it has not, check to see if your receiver/amplifier has a different surround-sound mode that you can use. • Review the operation of your DVD player and the DVD jacket to make sure that the DVD features the desired Dolby Digital or DTS® surround-sound mode and that you have properly selected that mode using both the DVD player's menu and the disc's menu.
If there is no sound coming from the <i>subwoofer</i> :	<ul style="list-style-type: none"> • Check that the subwoofer's Power cord is plugged into a working AC outlet. • Check that the subwoofer's Power switch is in the "ON" position. • Check that the Subwoofer Level control is not turned all the way down (fully counterclockwise). • Check the audio-cable connection between your receiver/processor and the subwoofer. • Check your receiver/amplifier's speaker-setup procedure to make sure that the subwoofer has been enabled and that its volume level has not been turned all the way down.
If the system plays at low volumes but shuts off as volume is increased:	<ul style="list-style-type: none"> • Make sure that all wires between the receiver/amplifier and the soundbar are connected properly. • Make sure that none of the speaker wires is frayed, cut or punctured. • If you have an additional pair of front speakers connected to your receiver/amplifier, make sure that you're not operating the system below the receiver/amplifier's minimum impedance requirements. Check the receiver/amplifier's documentation for more information.

You can find additional troubleshooting information in the FAQs link on the Support page at www.harmankardon.com.

Specifications

HKTS 5 System

Frequency response: 45Hz – 20kHz (–6dB)

	Satellites	Center
Recommended power:	10 – 80 watts	10 – 80 watts
Impedance:	8 ohms nominal	8 ohms nominal
Sensitivity:	86dB @ 1 watt/1 meter	86dB @ 1 watt/1 meter
Tweeter:	One 1/2" (12mm) dome	One 3/4" (19mm) dome
Midrange:	One 3" (75mm) driver	Dual 3" (75mm) drivers
Dimensions (H x W x D):	6-5/8" x 3-15/16" x 3-5/8" (167mm x 100mm x 92mm)	4" x 9-1/2" x 3-5/8" (102mm x 241mm x 92mm)
Weight:	1.45 lb (0.7kg) each	2..5 lb (1.1kg)

	HKTS 160SUB Subwoofer
Power requirement:	AC 120V, 60Hz (USA) AC 220V – 240V, 50/60Hz (EU)
Power consumption:	<0.55W (120V & 230V) standby 85W - 1.0A (120V) maximum 85W - 0.68A (230V) maximum
Amplifier power:	60 watts RMS
Low-frequency transducer:	8" (200mm) cone sealed enclosure
Dimensions (H x W x D):	13-29/32" x 10-1/2" x 10-1/2" (353mm x 267mm x 267mm)
Weight:	17.0 lb (7.7kg)



HARMAN

HARMAN Consumer, Inc.
8500 Balboa Boulevard, Northridge, CA 91329 USA

© 2012 HARMAN International Industries, Incorporated. All rights reserved.

Harman Kardon is a trademark of HARMAN International Industries, Incorporated, registered in the United States and/or other countries. Dolby, Pro Logic and the double-D symbol are registered trademarks of Dolby Laboratories. DTS is a registered trademark of DTS, Inc. CEA is a registered trademark of the Consumer Electronics Association.

Features, specifications and appearance are subject to change without notice.
Part No.

harman/kardon
by HARMAN

www.harmankardon.com